

SUPPLY SERVICES

performance engineering products

Performance Engineering Products
Keeping New Zealand Industry Moving

0800 102 112 | supplyservices.co.nz

Proud distributors of CAN-AM

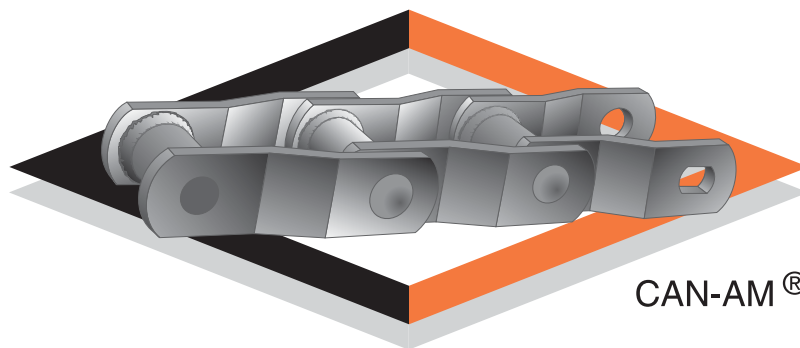

CAN-AM

Roller Chain
Leaf Chain
Sharp Top Chain

CAN-AM Products

visit us at www.can-amchains.com

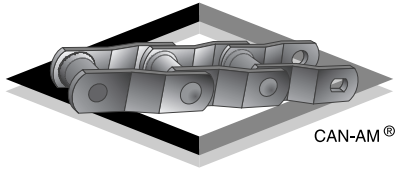

The origin of CAN-AM Chains dates back to 1966, and a small machine shop in Richmond, BC. Today three plants with more than 210,000 square feet of manufacturing space support 10 sales branches from coast to coast, making us the largest supplier of welded steel, specialty chains and roller chains in North America.

HEAD OFFICE USA

15151 S.E. Minuteman Way
P.O. Box 453
Clackamas, OR 97015
Phone (503) 657-1158
Fax (503) 656-7549
Toll Free 1-800-547-6274

SHREVEPORT BRANCH

2095 N. Hearne Ave.
Shreveport, LA 71107
Phone (318) 227-8006
Fax (318) 424-7751
Toll Free 1-800-321-8846

ALABASTER BRANCH

600 Galloway Circle
Alabaster, AL 35007
Phone (205) 942-2617
Fax (205) 942-4975
Toll Free 1-800-824-0674

ROCKY MOUNT BRANCH

7010 Stanley Park Dr.
Rocky Mount, NC 27804
Phone (252) 451-0636
Fax (252) 451-0833
Toll Free 1-888-856-0744

HEAD OFFICE CANADA

8355 128th Street
Surrey, B.C. V3W 4G1
Phone (604) 599-1522
Fax (604) 599-4115
Shipping (604) 594-5811
Toll Free 1-800-663-3136

BRITISH COLUMBIA BRANCH

9661 Penn Road
Prince George, BC V2N 5T6
Phone (250) 562-7727
Fax (250) 562-9603
Toll Free 1-877-399-3136

ALBERTA BRANCH

Unit 5 – 2002 8th Street
Nisku, Alberta T9E 7Y8
Phone (780) 955-3993
Fax (780) 955-3994
Toll Free 1-800-832-7556

ONTARIO BRANCH

5050 Dufferin Street
North York, Ontario M3H 5T5
Phone (416) 663-2626
Fax (416) 663-0774
Toll Free 1-800-265-3582

USA

E-mail:
usasales@can-amchains.com

CANADA

E-mail:
cansales@can-amchains.com

Standard Roller Chain2 & 3

Heavy Series Roller Chain4

British Standard Roller Chain5

Standard Roller Chain Attachment Links6 & 7

Leaf Chain8 & 9

Double Pitch Roller Chain10

Specialty Roller Chain Products11-13

Sharp Top Roller Chain – ST Series.....15-18

Sharp Top Roller Chain – SLL Series19-20

Sharp Top Roller Chain – 5 PEP Series.....21

Sharp Top Roller Chain – W2P/W4P Series.....22

Sharp Top Roller Chain – 160-1-DP & 32B Series23

Sharp Top Roller Chain – 80-2-4PEP Series24

ANSI STANDARD ROLLER CHAINS are more widely used for power transmission than any other type of chain. They are available in single and multiple strand construction. Double pitch drive chains are an economical choice for many slower speed drives. These chains conform to ANSI standards and are fully interchangeable with chains of like standards. They are equally efficient at low or high speeds and light or heavy loads. They are normally packaged in boxes containing 10' of chain and 1 connector link. Continuous reels of chain are available on request.



Challenge Us Today!

CAN-AM ANSI STANDARD ROLLER CHAINS

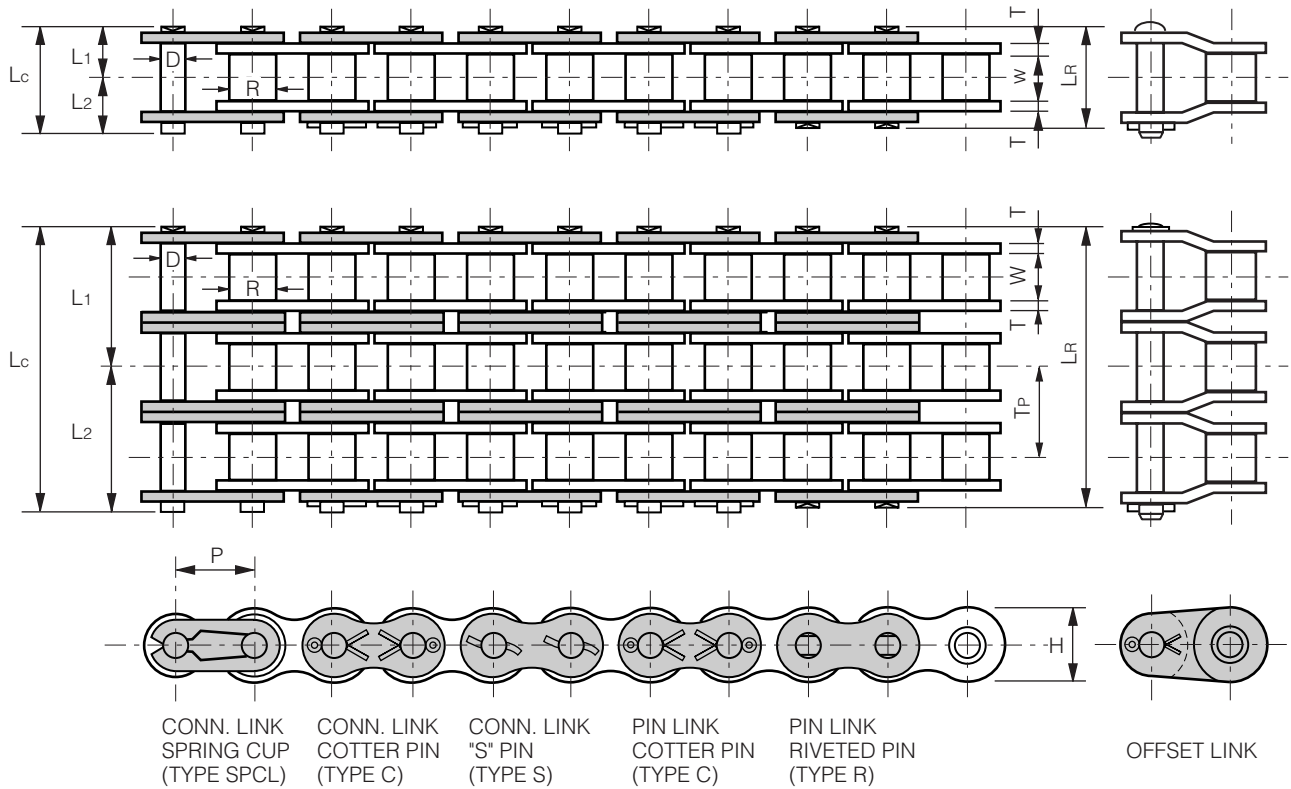

SINGLE STRAND

Chain Number (ANSI)	Dimensions – Inches										Average Ultimate Strength	Max. Allowable Load	Average Wt. Lbs./ Ft.	Type of Conn.
	Pitch	Roller		Pin					Plate					
		Width	Dia.	Dia.	Length			Height	Thickness					
P	W	R	D	LR	Lc	L1	L2	H	T	Lbs.	Lbs.	Ft.	Link	
* 25	1/4	1/8	0.130	0.0905	0.296	0.327	0.148	0.179	0.230	0.030	1050	140	.09	SpCl
* 35	3/8	3/16	0.200	0.141	0.466	0.500	0.233	0.267	0.354	0.050	2400	480	.21	
41	1/2	1/4	0.306	0.141	0.532	0.579	0.266	0.313	0.382	0.050	2600	500	.27	
40	1/2	5/16	0.312	0.156	0.646	0.682	0.323	0.359	0.463	0.060	4300	810	.41	
50	5/8	3/8	0.400	0.200	0.800	0.863	0.400	0.463	0.577	0.080	7200	1400	.68	
60	3/4	1/2	0.469	0.234	1.000	1.048	0.500	0.548	0.691	0.094	9900	1950	.96	
80	1	5/8	0.625	0.312	1.276	1.388	0.638	0.750	0.921	0.125	17600	3300	1.70	C
100	1 1/4	3/4	0.750	0.375	1.544	1.685	0.772	0.913	1.154	0.156	26400	5060	2.52	
120	1 1/2	1	0.875	0.437	1.942	2.095	0.971	1.124	1.382	0.187	39000	6800	3.64	
140	1 3/4	1	1.000	0.500	2.120	2.288	1.060	1.228	1.610	0.219	50900	9000	5.00	
160	2	1 1/4	1.125	0.562	2.524	2.697	1.262	1.435	1.839	0.250	63200	11900	6.53	
180	2 1/4	1 13/32	1.406	0.687	2.854	3.087	1.429	1.658	2.067	0.281	81500	13000	9.0	
200	2 1/2	1 1/2	1.562	0.781	3.084	3.418	1.542	1.876	2.354	0.312	105500	16000	10.6	S
240	3	1 7/8	1.875	0.936	3.799	4.098	1.900	2.198	2.768	0.375	152000	22000	15.9	

★ Rollerless chain. R indicates bushing diameter.

MULTIPLE STRANDS

Chain Number (ANSI)	Dimensions – Inches				Average Ultimate Strength	Max. Allowable Load	Avg. Wt Lbs./ Ft.
	Pitch	Traverse Pitch	Pin Length				
			P	TP	Riv. LR	Conn. LC	Lbs
35-2	3/8	0.398	0.864	0.906	4800	810	0.4
35-3			1.260	1.296	7200	1200	0.7
35-4			1.664	1.697	9600	1580	
35-5			2.062	2.091	12000	1870	
35-6			2.460	2.495	14400	2200	
40-2	1/2	0.567	1.260	1.248	8600	1370	0.8
40-3			1.764	1.815	12900	2025	1.28
40-4			2.362	2.376	17200	2670	1.70
40-5			2.936	2.959	21500	3160	2.12
40-6			3.502	3.522	25800	3720	2.55
50-2	5/8	0.712	1.504	1.583	14400	2380	1.35
50-3			2.232	2.288	21600	3500	2.08
50-4			2.952	2.983	28800	4620	2.76
50-5			3.668	3.707	36000	5460	3.45
50-6			4.386	4.432	43200	6440	4.14
60-2	3/4	0.898	1.890	1.945	19800	3315	1.9
60-3			2.772	2.843	29700	4875	3.05
60-4			3.716	3.727	39600	6435	4.06
60-5			4.608	4.644	49500	7600	5.07
60-6			5.520	5.538	59400	8970	6.08
60-8			7.282	7.373	79200	12000	
60-10			8.180	8.271	99000	14600	
80-2	1	1.153	2.425	2.539	35200	5610	3.82
80-3			3.579	3.705	52800	8250	5.30
80-4			4.742	4.863	70400	10890	7.06
80-5			5.898	6.016	88000	12870	8.81
80-6			7.052	7.170	105600	15180	10.57
80-8			9.354	9.471	140800	20400	
80-10			11.660	11.777	176000	24700	
100-2	1 1/4	1.409	2.950	3.102	52800	8600	5.27
100-3			4.360	4.512	79200	12650	7.91
100-4			5.804	5.938	105600	16690	10.55
100-5			7.206	7.347	132000	19700	13.12
100-6			8.616	8.756	158400	23200	15.78
100-8			11.434	11.579	211200	31300	
100-10			14.252	14.396	264000	37900	

Chain Number (ANSI)	Dimensions – Inches				Average Ultimate Strength	Max. Avg. Allowable Load	Avg. Wt Lbs./ Ft.
	Pitch	Traverse Pitch	Pin Length				
			P	TP	Riv. LR	Conn. LC	Lbs
120-2	1 1/2	1.787	3.740	3.890	78000	115600	7.86
120-3			5.531	5.685	117000	17000	11.78
120-4			7.328	7.481	156000	22440	15.70
120-5			9.116	9.268	195000	26520	19.59
120-6			10.902	11.057	234000	31280	23.49
120-8			14.468	14.364	312000	42100	
120-10			18.042	18.209	390000	51000	
140-2	1 3/4	1.925	4.055	4.224	101800	15300	9.65
140-3			5.966	6.146	152700	22500	14.90
140-4			7.922	8.091	203600	29700	19.16
140-5			9.848	10.016	254500	35100	24.84
140-6			11.772	11.941	305400	41400	29.77
140-8			15.612	15.792	407200	55800	
140-10			19.462	19.642	509000	67500	
160-2	2	2.303	4.828	5.000	126400	20230	13.47
160-3			7.146	7.315	189600	29750	20.17
160-4			9.462	9.634	252800	39270	26.92
160-5			11.764	11.941	316000	46410	35.52
160-6			14.072	14.241	329200	54740	40.27
160-8			18.678	18.851	505600	73700	
160-10			23.284	23.457	632000	89200	
180-2	2 1/4	2.587	5.441	5.670	163000	22100	17.82
180-3			8.051	8.276	244500	32500	25.68
180-4			10.638	10.863	326000	42900	34.20
180-5			13.226	13.450	407500	50700	42.73
180-6			15.814	16.037	489000	59800	51.25
200-2	2 1/2	2.819	5.906	6.241	211000	27200	21.50
200-3			8.722	9.213	316500	40000	32.94
200-4			11.548	11.906	422000	52800	43.79
200-5			14.390	14.729	527500	62400	54.64
200-6			17.210	17.544	633000	73600	58.65
240-2	3	3.457	7.252	7.551	304000	37400	32.32
240-3			10.708	11.008	456000	55000	48.11
240-4			14.166	14.465	608000	72600	63.90
240-5			17.624	17.922	760000	85800	79.70
240-6			21.082	21.379	912000	101200	95.49

CAN-AM HEAVY-SERIES ROLLER CHAINS

H-series roller chains provide greater shock and wear resistance as well as offering a 10 to 20% higher breaking strength than regular roller chain. The side plate thickness is equal to the next larger ANSI roller chain and incorporates through-hardened high-tensile steel pins. These chains deliver higher power transmission capacity than standard chain using the same space.

Single roller chains in this series run on standard single roller chain sprockets.

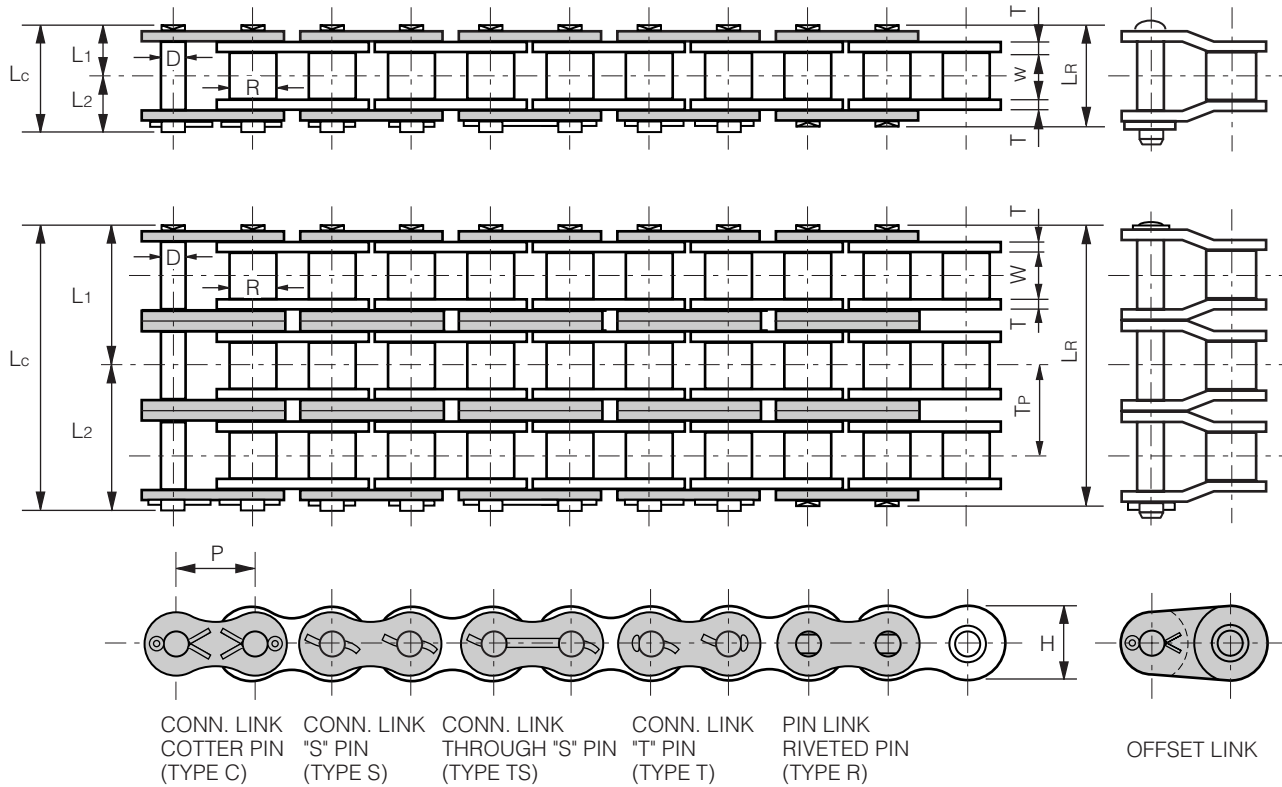

SINGLE STRAND

Chain Number (ANSI)	Dimensions – Inches										Average Ultimate Strength Lbs	Average Weight Lbs/Ft	Type of Conn. Link
	Pitch P	Roller		Pin				Plate					
		Width W	Dia. R	Dia. D	Length		Height H	Thickness T					
				LR	Lc	L1	L2						
60H	3/4	1/2	0.469	0.234	1.130	1.221	0.565	0.656	0.691	0.125	12300	1.21	C
80H	1	5/8	0.625	0.312	1.398	1.528	0.699	0.829	0.921	0.156	20200	1.89	C
100H	1 1/4	3/4	0.750	0.375	1.662	1.800	0.831	0.969	1.154	0.187	30800	2.78	C
120H	1 1/2	1	0.875	0.437	2.072	2.244	1.036	1.208	1.382	0.219	41800	3.92	C
140H	1 3/4	1	1.000	0.500	2.244	2.426	1.122	1.304	1.610	0.250	54200	5.65	C
160H	2	1 1/4	1.125	0.562	2.666	2.870	1.333	1.537	1.839	0.281	68700	7.30	C
180H	2 1/4	1 13/32	1.406	0.687	2.980	3.213	1.490	1.723	2.067	0.312	83700	10.20	C
200H	2 1/2	1 1/2	1.562	0.781	3.343	3.681	1.671	2.010	2.354	0.375	117000	12.00	S
240H	3	1 7/8	1.875	0.936	4.338	4.634	2.169	2.465	2.768	0.500	163100	21.70	S

CAN-AM BRITISH STANDARD ROLLER CHAINS

BS standard roller chains are standardized in accordance with ISO 606 "B" and fully interchangeable with chains manufactured according to BS 228 and DIN 8187. Supplied, in rivet type, to European countries as well as for replacement on machinery employing BS standard chains.

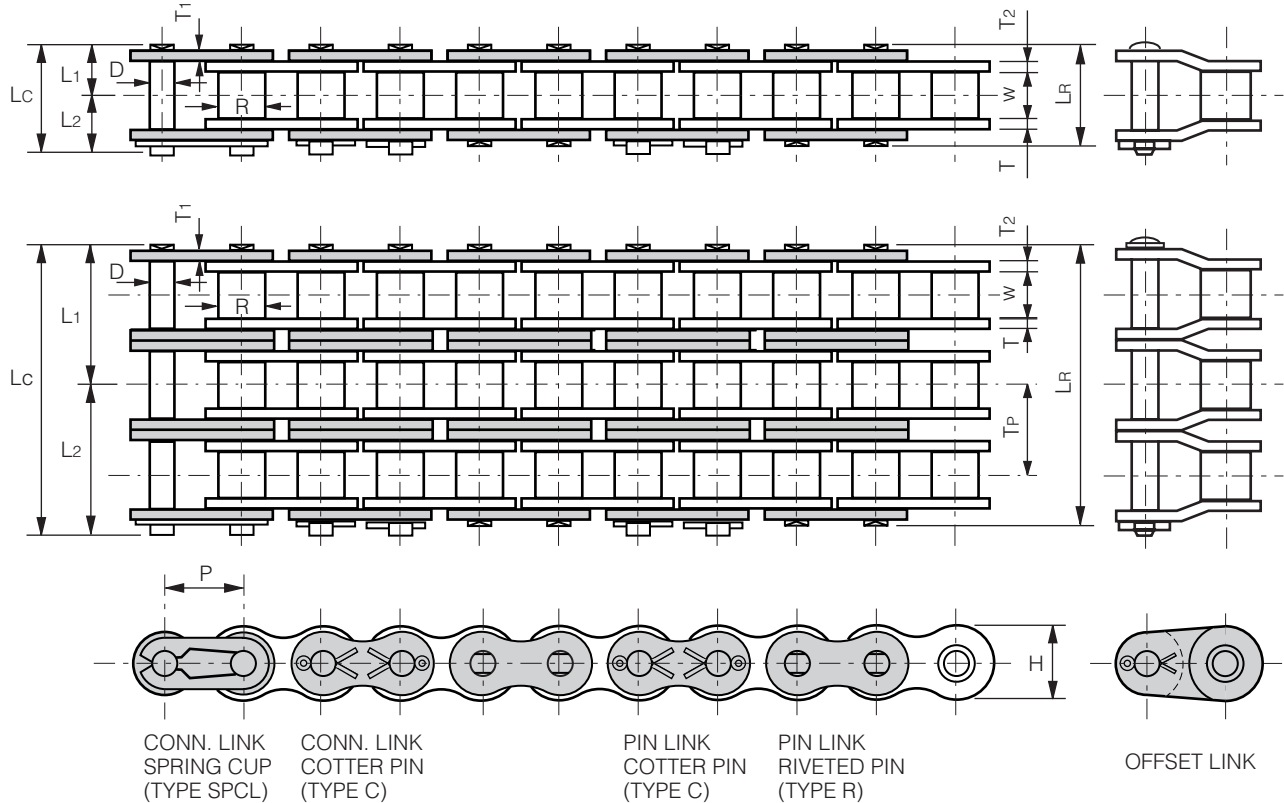

SINGLE STRAND

Chain Number (BS)	Dimensions – Inches											Minimum Ultimate Strength	Average Weight	Type of Conn. Link
	Pitch	Roller		Pin				Plate		Height	Thickness			
		Width	Dia.	Dia.	Length		T ₁	T ₂						
P	W	R	D	L _R	L _c	L ₁	L ₂	H	T ₁	T ₂	Lbs	Lbs/Ft		
06B	3/8	0.225	0.250	0.129	0.500	0.528	0.250	0.278	0.323	0.039	0.049	2000	0.289	Sp CL
08B	1/2	0.305	0.335	0.175	0.658	0.705	0.329	0.376	0.457	0.060		4040	0.409	Sp CL
10B	5/8	0.380	0.400	0.200	0.748	0.811	0.374	0.437	0.571	0.065		5040	0.600	Sp CL
12B	3/4	0.460	0.475	0.225	0.878	0.933	0.439	0.494	0.626	0.070		6550	0.769	Sp CL
16B	1	0.670	0.625	0.325	1.382	1.496	0.691	0.805	0.792	0.122	0.154	15550	1.743	C
20B	1 1/4	0.770	0.750	0.400	1.582	1.744	0.791	0.953	1.024	0.138	0.178	22200	2.528	C
24B	1 1/2	1.000	1.000	0.576	2.100	2.303	1.050	1.253	1.315	0.193	0.233	37750	4.900	C
28B	1 3/4	1.220	1.100	0.625	2.563	2.807	1.282	1.525	1.440	0.250	0.291	46650	6.222	C
32B	2	1.220	1.150	0.701	2.567	2.835	1.284	1.550	1.642	0.250	0.272	53350	6.667	C
40B	2 1/2	1.500	1.550	0.901	3.178	3.504	1.589	1.915	2.083	0.312	0.335	80000	11.600	C

CAN-AM ANSI SERIES ROLLER CHAIN ATTACHMENT

BENT LUG ATTACHMENTS

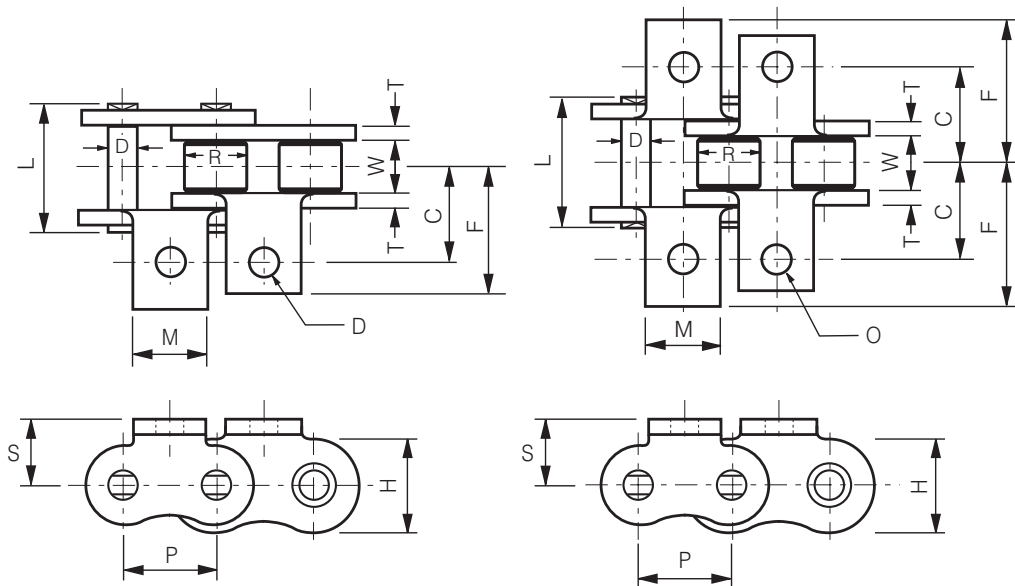

A-1 (BENT LUG 1 SIDE -1 HOLE)

K-1 (BENT LUG 2 SIDES -1 HOLE)

A-1 & K-1 ATTACHMENT DIMENSIONS

Chain Number	Dimensions – Inches				A-1		K-1		A-1 Additional Wgt/Att. Lbs/pc	K-1 Additional Wgt/Att. Lbs/pc
		Tab Width	Hole Dia.	Attach. Plate Height	C/L to Att. Hole	C/L to Att. End	Across Att. Holes	Overall Width		
		M	O	S	C	F	2C	2F		
35	-	5/16	0.109	0.250	0.375	0.562	0.750	1.124	0.002	0.004
40	-	3/8	0.140	0.312	0.500	0.679	1.000	1.358	0.003	0.006
50	-	1/2	0.205	0.406	0.625	0.917	1.250	1.834	0.009	0.018
60	-	5/8	0.205	0.468	0.750	1.106	1.500	2.212	0.014	0.028
80	-	3/4	0.265	0.625	1.000	1.413	2.000	2.826	0.030	0.060
100	-	1	0.343	0.781	1.250	1.742	2.500	3.484	0.059	0.118
120	-	1 1/8	0.406	0.906	1.500	2.154	3.000	4.308	0.105	0.210
140	-	1 3/8	0.469	1.125	1.750	2.485	3.500	4.970	0.157	0.314
160	-	1 1/2	0.547	1.250	2.000	2.828	4.000	5.656	0.214	0.428

CAN-AM ANSI SERIES ROLLER CHAIN ATTACHMENT

STRAIGHT LUG ATTACHMENTS

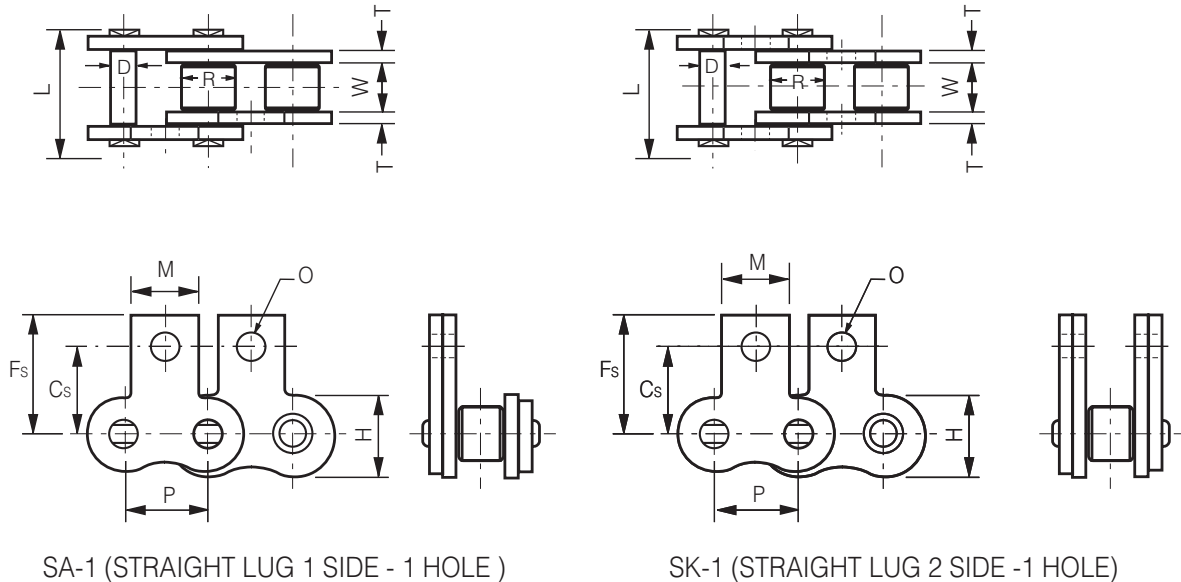

SA-1 & SK-1 ATTACHMENT DIMENSIONS

Dimensions Chain Number	Inches	SA-1 & SK-1		SA-1	SK-1				Additional Wgt/Att. Lbs/pc	Additional Wgt/Att. Lbs/pc
		Tab Width M	Hole Dia. O		C/L to Att. Hole Cs	C/L to Att. Top Fs				
35	-	5/16	0.109	-	0.375	0.578	-	-	0.002	0.004
40	-	3/8	0.141	-	0.500	0.734	-	-	0.003	0.006
50	-	1/2	0.203	-	0.625	0.906	-	-	0.009	0.018
60	-	5/8	0.203	-	0.719	1.062	-	-	0.014	0.028
80	-	3/4	0.265	-	0.969	1.359	-	-	0.030	0.060
100	-	1	0.343	-	1.250	1.700	-	-	0.059	0.118
120	-	1 1/8	0.406	-	1.437	2.031	-	-	0.105	0.210
140	-	1 3/8	0.469	-	1.750	2.484	-	-	0.157	0.314
160	-	1 1/2	0.547	-	2.000	2.734	-	-	0.214	0.428

CAN-AM LEAF CHAINS

Leaf chains are well-suited for any application requiring flexible, high-strength linkage for reciprocating motion or lifting at relatively low speed. For their low cost and long life, these chains are widely used for lift trucks, masts and other lifting as well as construction, mining machines and balance or counterweights of machine tools.

Construction and Lacing Combinations

Built of interlaced plates held together by riveted pins. The chain nomenclature indicates the lacing combinations.

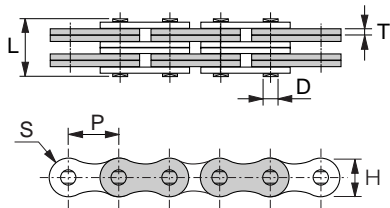
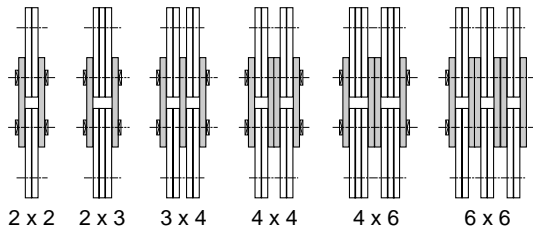

AL Series (Light Duty)

Consisting of link plates of the same contour and thickness as the pin link plates of ANSI roller chains in the same pitch. Mainly used for relatively constant, low, medium load with less shock.

BL Series (Heavy Duty)

Consisting of link plates with the thickness of the next larger size of ANSI roller chain. Chiefly used for medium load with greater shock.

Chain Number	Lacing	Dimensions – Inches						Average Ultimate Strength Lbs	Average Weight Lbs/Ft.
		Pitch P	Pin		Plate		Hole Dia. (min.) S		
			Dia. D	Length L	Height H	Thickness T			
AL 422	2 x 2	1/2	0.156	0.331	0.406	0.060	0.1598	4000	0.24
AL 444	4 x 4			0.587				8000	0.47
AL 466	6 x 6			0.831				12000	0.70
AL 522	2 x 2	5/8	0.200	0.425	0.500	0.080	0.2019	6600	0.39
AL 544	4 x 4			0.760				13200	0.78
AL 566	6 x 6			1.102				19800	1.16
AL 622	2 x 2	3/4	0.234	0.550	0.598	0.094	0.2374	9360	0.54
AL 644	4 x 4			0.894				18720	1.13
AL 666	6 x 6			1.295				28080	1.65
AL 822	2 x 2	1	0.312	0.665	0.795	0.125	0.3149	16000	0.95
AL 844	4 x 4			1.169				32000	1.94
AL 866	6 x 6			1.705				48000	2.84
AL 1022	2 x 2	1 1/4	0.375	0.783	0.965	0.156	0.3775	24200	1.65
AL 1044	4 x 4			1.437				48400	3.23
AL 1066	6 x 6			2.118				72600	4.86
AL 1222	2 x 2	1 1/2	0.437	0.965	1.150	0.187	0.4417	32000	2.25
AL 1244	4 x 4			1.732				64000	4.42
AL 1266	6 x 6			2.508				96000	6.60
AL 1422	2 x 2	1 3/4	0.500	1.114	1.346	0.219	0.5047	46000	3.35
AL 1444	4 x 4			2.028				92000	6.42
AL 1466	6 x 6			2.909				138000	9.49
AL 1622	2 x 2	2	0.562	1.263	1.587	0.250	0.5669	60600	4.27
AL 1644	4 x 4			2.311				121200	8.48
AL 1666	6 x 6			3.350				181800	12.68

Chain Number	Lacing	Dimensions – Inches						Average Ultimate Strength	Average Weight
		Pitch	Pin		Plate		Hole Dia. (min.)		
			Dia.	Length	Height	Thickness			
P	D	L	H	T	S	Lbs	Lbs/Ft.		
BL 422	2 x 2	1/2	0.200	0.425	0.463	0.080	0.2019	6100	0.43
BL 423	2 x 3			0.504				6100	0.53
BL 434	3 x 4			0.673				9200	0.72
BL 444	4 x 4			0.760				12200	0.82
BL 446	4 x 6			0.925				12200	1.06
BL 466	6 x 6			1.102				18400	1.27
BL 522	2 x 2	5/8	0.234	0.500	0.577	0.094	0.2374	9000	0.68
BL 523	2 x 3			0.602				9000	0.80
BL 534	3 x 4			0.807				13600	1.08
BL 544	4 x 4			0.894				18000	1.21
BL 546	4 x 6			1.106				18900	1.52
BL 566	6 x 6			1.295				27200	1.78
BL 622	2 x 2	3/4	0.312	0.673	0.691	0.125	0.3153	14300	1.03
BL 623	2 x 3			0.780				14300	1.27
BL 634	3 x 4			1.051				21450	1.80
BL 644	4 x 4			1.169				28600	2.04
BL 646	4 x 6			1.453				28600	2.79
BL 666	6 x 6			1.709				42900	3.08
BL 822	2 x 2	1	0.375	0.783	0.950	0.156	0.3779	23100	1.73
BL 823	2 x 3			0.957				23100	2.13
BL 834	3 x 4			1.291				34800	2.94
BL 844	4 x 4			1.445				46200	3.33
BL 846	4 x 6			1.787				46200	4.19
BL 866	6 x 6			2.122				69600	5.00
BL 1022	2 x 2	1 1/4	0.437	0.965	1.154	0.187	0.4409	34000	2.51
BL 1023	2 x 3			1.138				34000	3.12
BL 1034	3 x 4			1.539				51000	4.37
BL 1044	4 x 4			1.736				68000	4.98
BL 1046	4 x 6			2.118				68000	6.19
BL 1066	6 x 6			2.512				102000	7.44
BL 1222	2 x 2	1 1/2	0.500	1.114	1.382	0.219	0.5047	44600	3.21
BL 1223	2 x 3			1.362				44600	4.34
BL 1234	3 x 4			1.807				66900	6.08
BL 1244	4 x 4			2.012				89200	6.90
BL 1246	4 x 6			2.480				89200	7.97
BL 1266	6 x 6			2.913				133800	9.68
BL 1422	2 x 2	1 3/4	0.562	1.267	1.610	0.250	0.5665	60600	4.87
BL 1423	2 x 3			1.543				60600	5.98
BL 1434	3 x 4			2.051				90900	7.80
BL 1444	4 x 4			2.315				121200	8.65
BL 1446	4 x 6			2.819				121200	12.00
BL 1466	6 x 6			3.354				181800	15.01
BL 1622	2 x 2	2	0.687	1.425	1.839	0.281	0.6937	84300	6.57
BL 1623	2 x 3			1.736				84300	8.12
BL 1634	3 x 4			2.334				126450	11.32
BL 1644	4 x 4			2.610				168600	12.67
BL 1646	4 x 6			3.173				168600	16.09
BL 1666	6 x 6			3.803				252900	19.18
BL 2022	2 x 2	2 1/2	0.936	1.889	2.354	0.375	0.9389	124000	9.66
BL 2023	2 x 3			2.283				124000	11.98
BL 2034	3 x 4			3.070				186000	16.68
BL 2044	4 x 4			3.460				248000	19.03
BL 2046	4 x 6			4.248				248000	23.70
BL 2066	6 x 6			5.393				372000	28.11

CAN-AM DOUBLE PITCH ROLLER CHAINS

DRIVE SERIES

Double Pitch, light series power transmission roller chains are a series of roller chains which incorporates pins, bushings and rollers similar in dimensions to the ANSI Standard series roller chains, but with side-plates providing a pitch twice as great.

They are lighter in weight and lower in price than the ANSI standard series roller chains, but they have only one-half the number of pin-bushing joints per foot. Consequently, joint articulation is greater on the same diameter sprockets, so they will not provide as long a service life as an ANSI standard series roller chain.

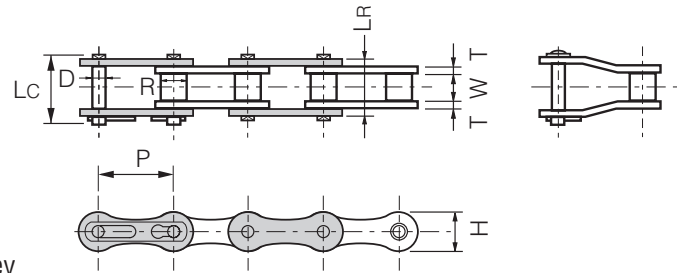

Chain Number (ANSI)	Dimensions – Inches								Average Ultimate Strength (Lbs)	Average Weight (Lbs/Ft)	Type of Conn. Link
	Pitch (P)	Roller		Pin			Plate				
		Width (W)	Dia. (R)	Dia. (D)	Length (LR)	LC	Height (H)	Thickness (T)			
A2040	1	5/16	0.312	0.156	0.646	0.728	0.450	0.060	4300	0.32	C
A2050	1 1/4	3/8	0.400	0.200	0.800	0.878	0.591	0.080	7200	0.55	
A2060	1 1/2	1/2	0.469	0.234	1.000	1.087	0.670	0.094	9900	0.69	
A2080	2	5/8	0.625	0.312	1.276	1.388	0.890	0.125	17600	1.15	

CONVEYOR SERIES – Standard Roller Type

C-2000 conveyor series chains have rollers of the same diameters and widths as those of ANSI standard roller chains but the pitch of the chains is twice that of the corresponding ANSI standard roller chains.

Side plates are straight-edged and unbeveled. Contours of roller link plates and pin link plates are identical, providing substantial contact areas when chains slide on supporting surfaces.

– Carrier Roller Type

C-2002 conveyor series chains with carrier rollers are the same as the C-2000 series conveyor chains except that the roller diameters are greater so that the rollers project beyond the chain link plates. These chains roll on the flat surfaces with minimum friction.

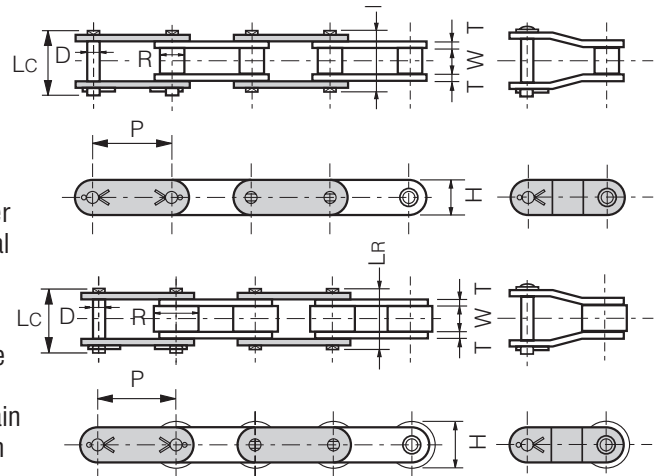

Chain Number (ANSI)	Dimensions – Inches								Average Ultimate Strength (Lbs)	Average Weight (Lbs/Ft)	Type of Conn. Link
	Pitch (P)	Roller		Pin			Plate				
		Width (W)	Dia. (R)	Dia. (D)	Length (LR)	LC	Height (H)	Thickness (T)			
C2040	1	5/16	0.312	0.156	0.646	0.728	0.450	0.060	4300	0.32	C
C2042			0.625							0.55	
C2050	1 1/4	3/8	0.400	0.200	0.800	0.878	0.591	0.080	7200	0.55	
C2052			0.750							0.85	
C2060H	1 1/2	1/2	0.469	0.234	1.130	1.221	0.670	0.125	12300	0.93	
C2062H			0.875							1.40	
C2080H	2	5/8	0.625	0.312	1.398	1.528	0.890	0.156	20200	1.56	
C2082H			1.125							2.26	
C2100H	2 1/2	3/4	0.750	0.375	1.662	1.800	1.126	0.187	30800	2.33	
C2102H			1.562							3.80	
C2120H	3	1	0.875	0.437	2.072	2.244	1.374	0.219	41800	3.31	
C2122H			1.750							5.30	
C2160H	4	1 1/4	1.125	0.562	2.666	2.870	1.874	0.281	68700	5.40	
C2162H			2.250							8.60	

CAN-AM SPECIALTY ROLLER CHAIN PRODUCTS

AQUA-PROOF ROLLER CHAIN *

Excellent corrosion resistance without plating. Same strength and working load values as standard chain. No hydrogen embrittlement by surface treatment. For identification, a suffix "AP" is added to the chain numbers.

SALT SPRAY TEST

Chains	Hour for Rust developed (hrs)
Nickel plated	48
Special Surface treated *	600 ~ 840
Made of SUS304 Stainless Steel	above 840 ~ No rust

NICKEL-PLATED CHAINS

Ideal for outdoor operations and in situations where machinery and equipment must be run in a lightly corrosive atmosphere or where good chain appearance may be desired.

For identification, a suffix "NP" is added to the chain numbers.

STAINLESS STEEL CHAINS

CAN-AM stainless steel roller chains are recommended for use in such unusual atmospheres as water, acid, alkali, humidity, high or low temperature which corrode the standard roller chains and shorten their life. Their real worth will be proven in the food processing industry where rust, scale, oil, etc, are unacceptable. For identification, a suffix "SS" is added to the chain numbers.

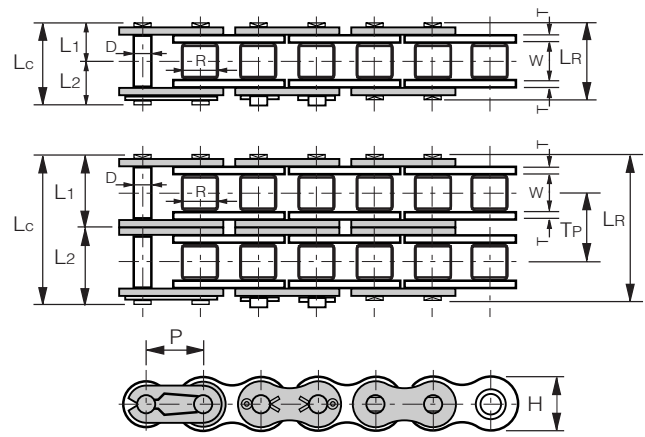

Aqua-Proof Chain Number	Nickel-Plated Chain Number	Stainless Steel Chain Number	Pitch	Dimensions – Inches										Max. Allowable Load Lbs	Average Weight Lbs/Ft
				Roller		Pin				Plate		Traverse Pitch			
				Width	Dia.	Dia.	Length		Height	Thickness					
P	W	R	D	LR	Lc	L1	L2	H	T	TP	Lbs	Lbs/Ft			
-	35 NP	35 SS	3/8	3/16	0.200	0.141	0.466	0.500	0.233	0.267	0.354	0.050	-	60	0.23
40 AP	40 NP	40 SS	1/2	5/16	0.312	0.156	0.646	0.682	0.323	0.359	0.463	0.060	-	100	0.40
50 AP	50 NP	50 SS	5/8	3/8	0.400	0.200	0.800	0.863	0.400	0.463	0.577	0.080	-	160	0.66
60 AP	60 NP	60 SS	3/4	1/2	0.469	0.234	1.000	1.048	0.500	0.548	0.691	0.094	-	230	0.98
80 AP	80 NP	80 SS	1	5/8	0.625	0.312	1.276	1.388	0.638	0.750	0.921	0.125	-	400	1.69
100 AP	100 NP	100 SS	1 1/4	3/4	0.750	0.375	1.544	1.685	0.772	0.913	1.154	0.156	-	580	2.63
120 AP	-	120 SS	1 1/2	1	0.875	0.437	1.942	2.095	0.971	1.124	1.382	0.187	-	870	3.87
140 AP	-	140 SS	1 3/4	1	1.000	0.500	2.120	2.288	1.060	1.228	1.610	0.219	-	1040	4.98
160 AP	-	160 SS	2	1 1/4	1.125	0.562	2.524	2.697	1.262	1.435	1.839	0.250	-	1440	6.58
-	35 NP-2	-	3/8	3/16	0.200	0.141	0.864	0.906	0.432	0.474	0.354	0.050	0.398	4800	0.42
-	40 NP-2	-	1/2	5/16	0.312	0.156	1.206	1.248	0.603	0.645	0.463	0.060	0.567	8600	0.82
-	50 NP-2	-	5/8	3/8	0.400	0.200	1.504	1.583	0.752	0.831	0.577	0.080	0.712	14400	1.34
-	60 NP-2	-	3/4	1/2	0.469	0.234	1.890	1.945	0.945	1.000	0.691	0.094	0.898	19800	1.98
-	80 NP-2	-	1	5/8	0.625	0.312	2.425	2.539	1.213	1.327	0.921	0.125	1.153	35200	3.43
-	100 NP-2	-	1 1/4	3/4	0.750	0.375	2.950	3.102	1.475	1.627	1.154	0.156	1.409	52800	5.20

CAN-AM SPECIALTY ROLLER CHAIN PRODUCTS

FLAT TOP (TABLE TOP) CONVEYOR CHAINS

CAN-AM TT-type top chains are made of only two parts – AISI 403 top plates with curled hinged pins – as a standard. This simple construction assures high strength, longer service life and easy washing for sanitation and maintenance. Widely used in food, beverage, packaging, automation, electronic parts and other handling operations. Standard chains will be furnished unless otherwise specified. Chains of AISI 430 and AISI 304 may be supplied upon request.

Maximum working load – 350 lbs.

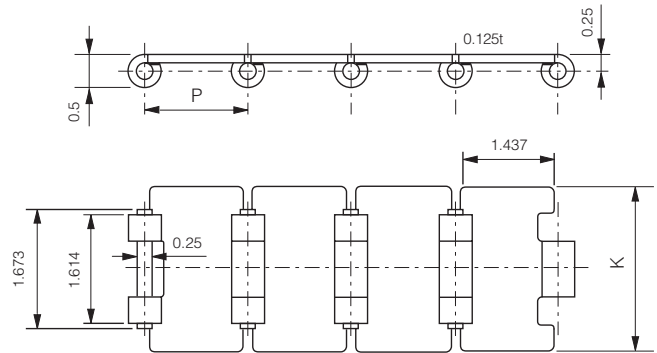

Chain Number	Dimensions – Inches		Average Weight Lbs/Ft
	Pitch P	Width of Pitch K	
	TT-22	1.500	
TT-24		2.500	1.48
TT-30		3.000	1.68
TT-32		3.250	1.75
TT-34		3.500	1.82
TT-36		3.950	1.86

Chain Number	Dimensions – Inches		Average Weight Lbs/Ft
	Pitch P	Width of Pitch K	
	TT-40	1.500	
TT-44		4.500	2.29
TT-50		5.000	2.36
TT-60		6.000	2.77
TT-64		6.500	2.96
TT-74		7.500	3.40

TOP PLATE CONVEYOR CHAINS

CAN-AM TP-type top chains consist of top plates (made of ANSI 403 as a standard) and steel roller chains identical to A2060. The top plates are accurately and firmly attached to the link plates of the chain. Standard top chains will be supplied unless otherwise specified. Chains with AISI 430 and AISI 304 parts throughout, as nickel-plated chains, may be furnished if desired on a made-to-order basis.

Maximum working load – 550 lbs.

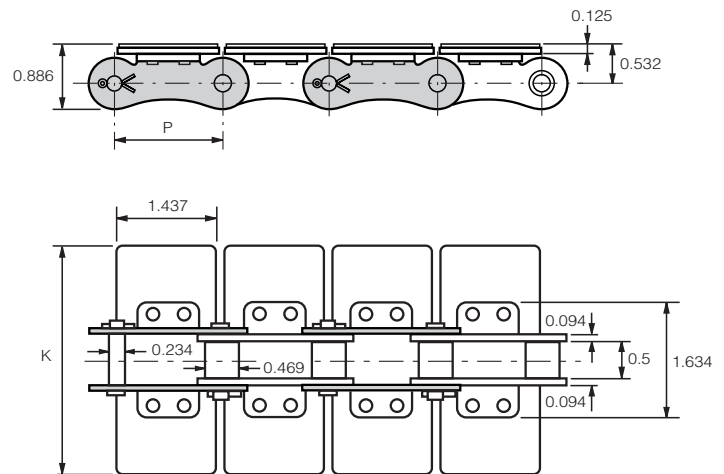

Chain Number	Dimensions – Inches		Average Weight Lbs/Ft
	Pitch P	Width of Pitch K	
	TP-24	1.500	
TP-26		2.750	2.00
TP-30		3.000	2.11
TP-32		3.250	2.20
TP-34		3.500	2.30

Chain Number	Dimensions – Inches		Average Weight Lbs/Ft
	Pitch P	Width of Pitch K	
	TP-40	1.500	
TP-44		4.500	2.68
TP-50		5.000	2.89
TP-60		6.000	3.32
TP-64		6.500	3.51

CAN-AM SPECIALTY ROLLER CHAIN PRODUCTS

E & S SERIES ROLLER CHAINS

E-Series roller chains have sharply improved fatigue resistance to repeated load by employing superior-grade special steel pins. Sizes are identical to ANSI standard roller chains and interchangeable with them.

S-Series roller chains are designed for high-breaking strength and maximum endurance. Combination of plates one size thicker than standard and thick, tough pins ensures accurate operation and long performance life under harsh, heavy loads. Single strand roller chains of this series run on standard single roller chain sprockets.

HE-SERIES ROLLER CHAINS

HE-Series roller chains have greater shock resistance, fatigue strength and breaking strength than the H-Series. Plates one size thicker than standard roller chains and highest-class pins employed prove their worth in operation at low and medium speeds. Single strand roller chains of this series operate on standard single roller chain sprockets.

SUPER-SERIES ROLLER CHAINS

Super-Series roller chains are developed to offer you longer service life, thus leading to labor savings. Thorough consideration of fitting portions and plate configurations and the use of high-grade special alloy steel components ensure the chain's greater resistance to fatigue and shock. Operative on standard roller chain sprockets. Super-heavy-duty series – roller chains provided with link plates of next larger chain sizes and offers you higher performance and superior quality.

OIL-FIELD CHAINS

Oil-field chains are manufactured in accordance with ANSI, API standards and officially approved by The American Petroleum Institute for high quality, reliability and long trouble-free service life. Used in oilfield drilling and producing operations such as hoisting, pumping and drawworks.

SELF-LUBE CHAINS

Self-Lube roller chains being self-lubricating assure seizure-free, and long-wear life where normal lubrication is not possible, undesirable, or restricted on such machines as food processing, textile, packing and printing/binding. Interchangeable with ANSI roller chains and workable on standard ANSI sprockets. For identification, a suffix "SL" is added to the chain numbers.

SIDE BOW CHAINS

Side Bow chains are provided with "extra clearance" between pins, bushings and link plates to permit freedom of operation around a curve or in a twist. The basic dimensions, quality and finish are the same as those of ANSI standard roller chains. Widely used for live-roll conveyors and with attachments or cross-slats to convey products or materials around curves. For identification, a suffix "SB" is added to the chain numbers.

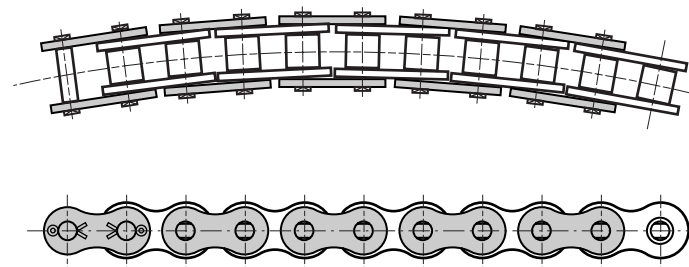

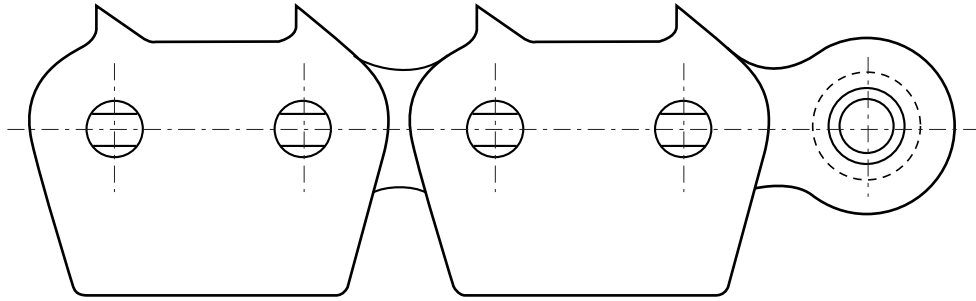

CAN-AM

Sharp Top Roller Chains

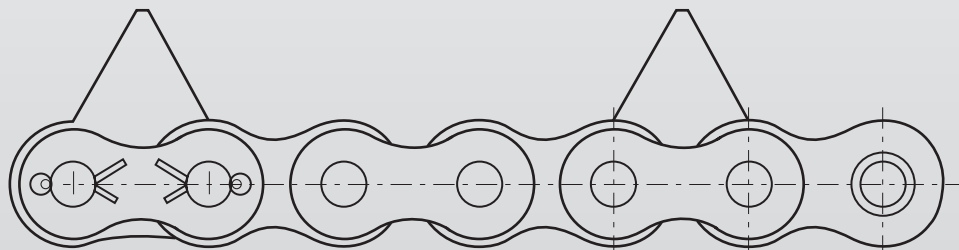
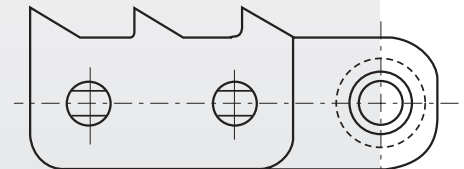
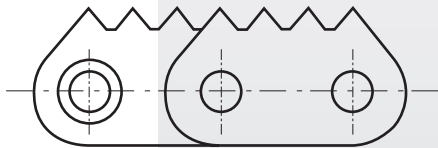

CAN-AM SHARP TOP CHAINS

3-POINT (ST) SERIES – SINGLE STRAND

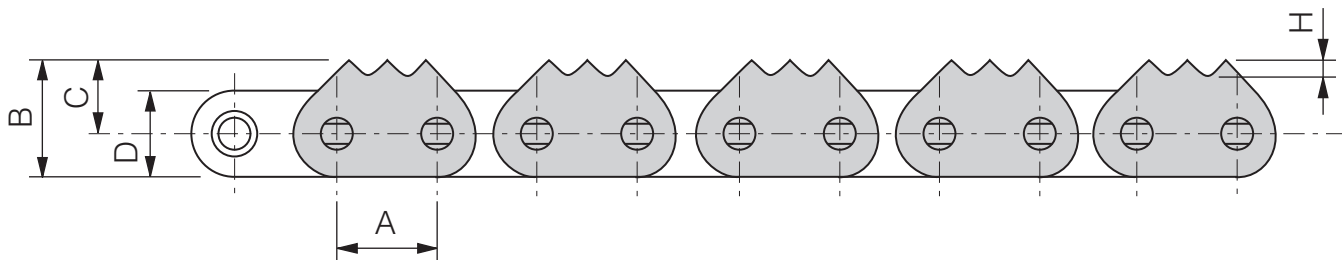
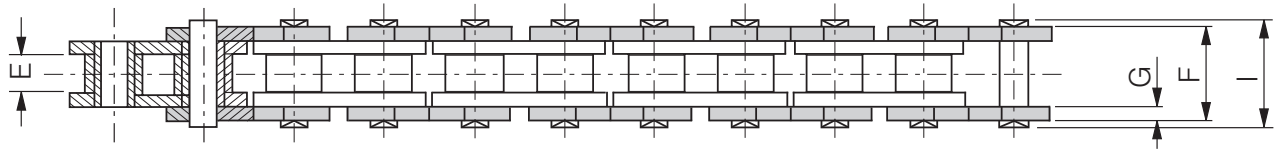

SINGLE STRAND

Chain Number	A	B	C	D	E	F	G	H	I
60-1 ST	0.750	0.850	0.512	0.689	0.500	0.878	0.094	0.094	1.000
80-1 ST	1.000	1.140	0.685	0.914	0.622	1.130	0.125	0.125	1.275
100-1 ST	1.250	1.325	0.750	1.142	0.711	1.374	0.156	0.125	1.544
120-1 ST	1.500	1.594	0.909	1.370	1.000	1.750	0.187	0.125	1.942

CAN-AM SHARP TOP CHAINS

3-POINT (ST) SERIES – DUPLEX

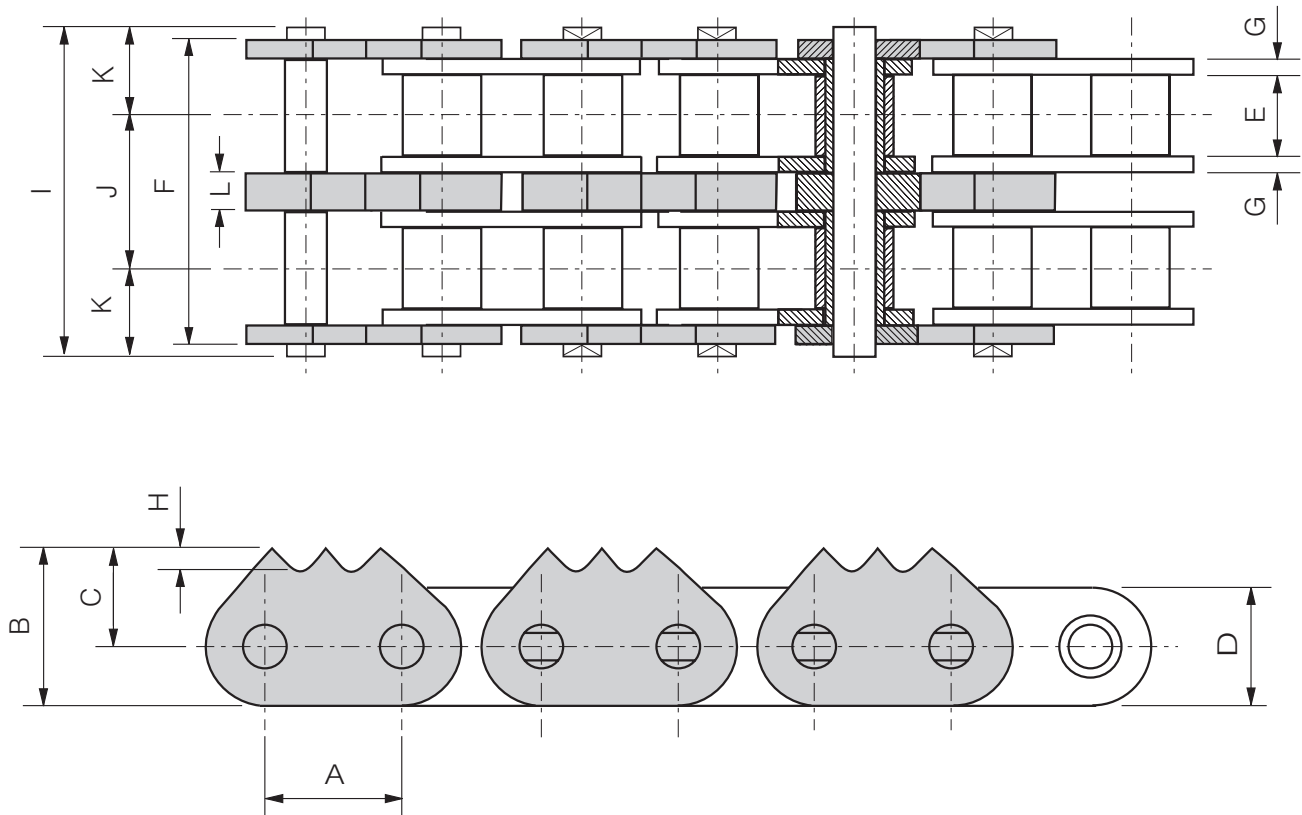

DUPLEX

Chain Number	A	B	C	D	E	F	G	H	I	J	K	L
60-2 ST	0.750	0.854	0.510	0.685	0.500	1.774	0.094	0.094	1.900	0.898	0.500	-
80-2 ST	1.000	1.140	0.685	0.914	0.625	2.310	0.125	0.125	2.420	1.153	0.630	0.249
100-2 ST	1.250	1.325	0.715	1.147	0.750	2.805	0.156	0.125	2.953	1.409	0.772	0.310
120-2 ST	1.500	1.594	0.909	1.370	1.000	3.300	0.187	0.125	3.729	1.787	0.970	0.410

CAN-AM SHARP TOP CHAINS

3-POINT (ST) SERIES – TRIPLEX

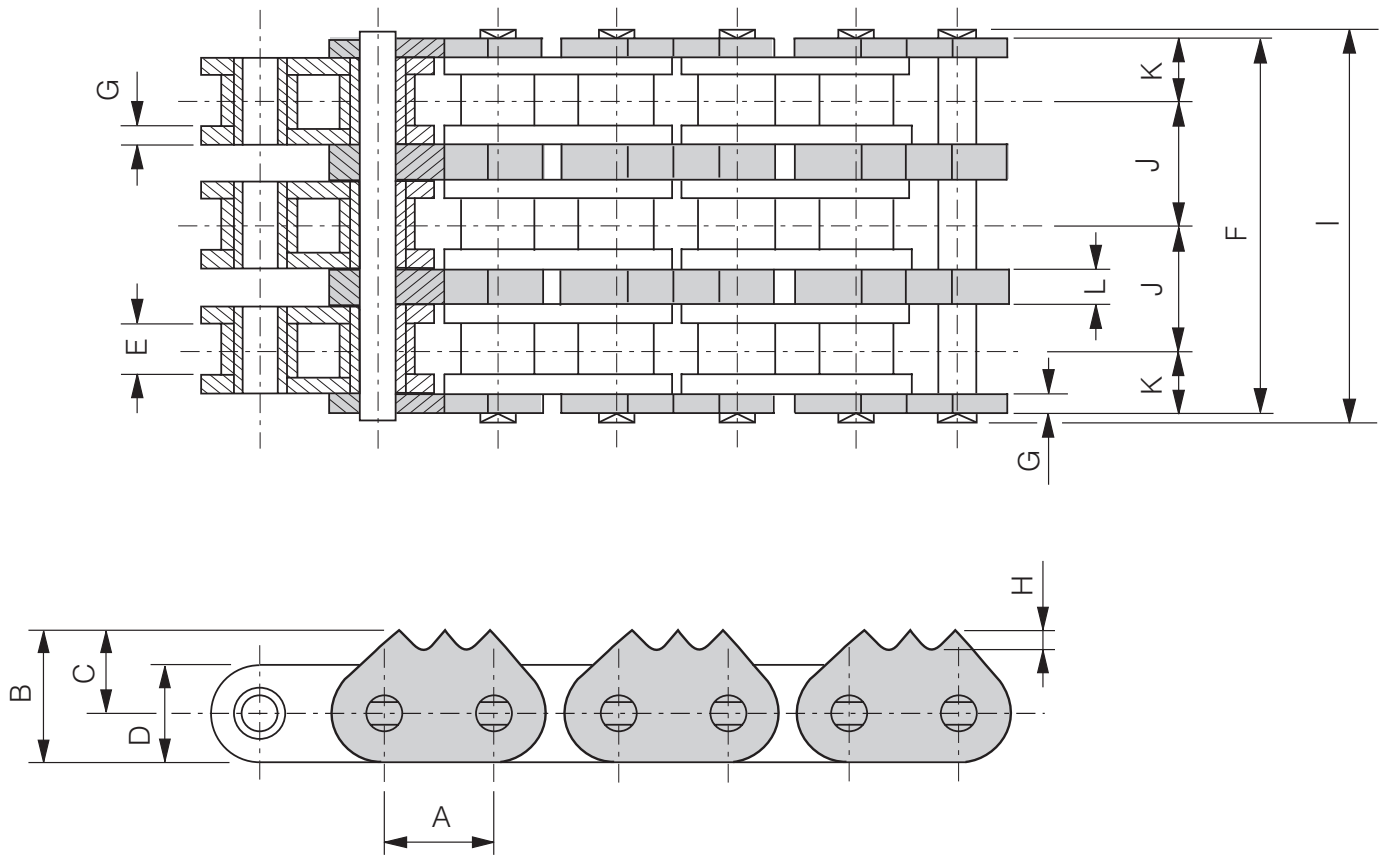

TRIPLEX

Chain Number	A	B	C	D	E	F	G	H	I	J	K	L
80-3 ST	1.000	1.140	0.685	0.914	0.625	3.460	0.125	0.126	3.580	1.153	0.650	0.250
100-3 ST	1.250	1.325	0.754	1.147	0.750	4.200	0.156	0.126	4.362	1.409	0.772	0.310

CAN-AM SHARP TOP CHAINS

3-POINT (ST) SERIES – QUAD

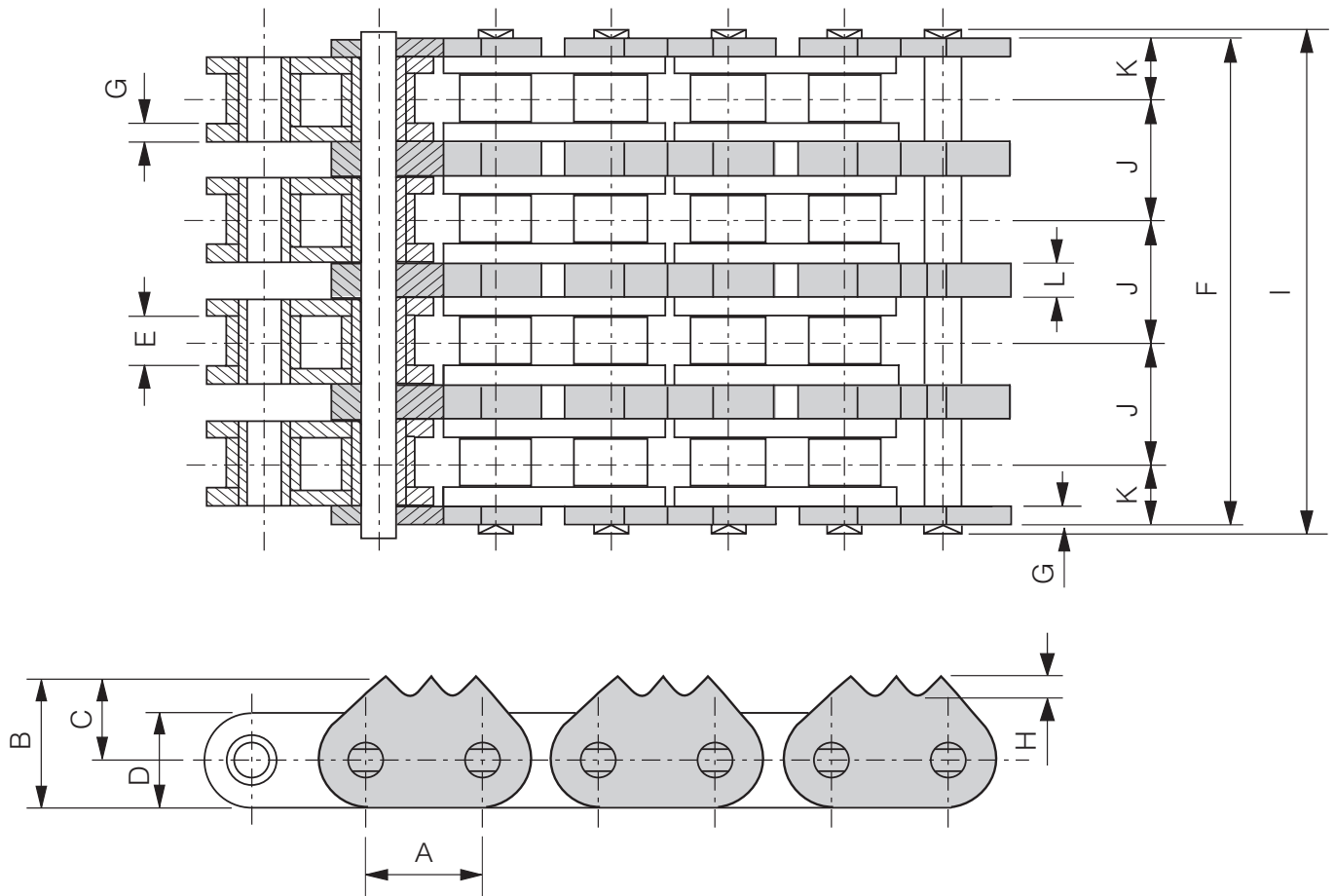

QUAD

Chain Number	A	B	C	D	E	F	G	H	I	J	K	L
80-4 ST	1.000	1.140	0.685	0.914	0.625	4.614	0.125	0.126	4.740	1.153	0.645	0.250
120-4 ST	1.500	1.594	0.909	1.370	1.000	7.150	0.187	0.125	7.303	1.787	0.970	0.410

CAN-AM SHARP TOP CHAINS

2-POINT 80 (SLL) SERIES

"SLASHER LOW PROFILE"

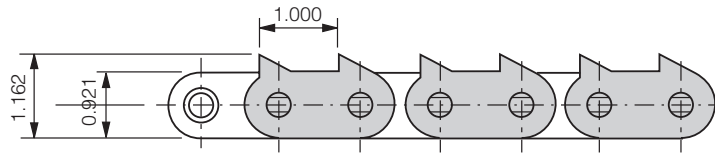

80-1 SLL

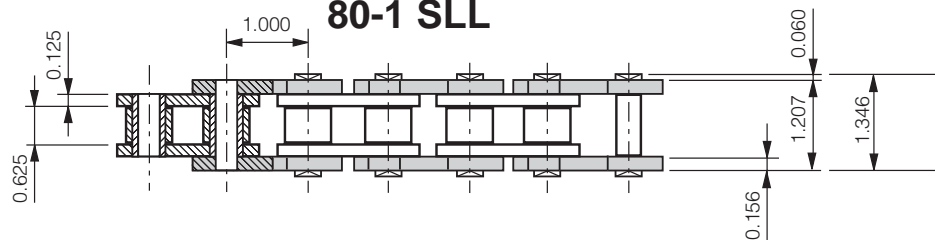

80-2 SLL

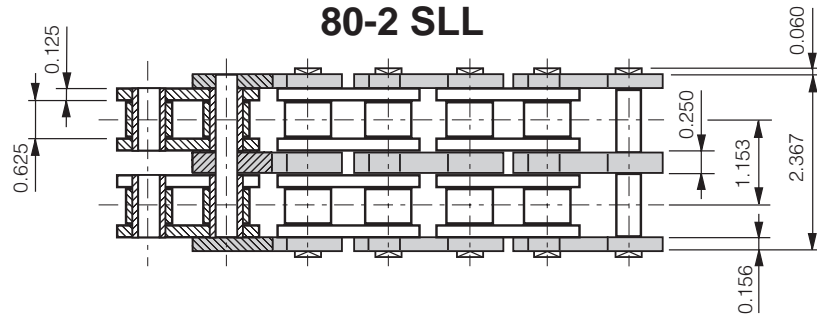

80-3 SLL

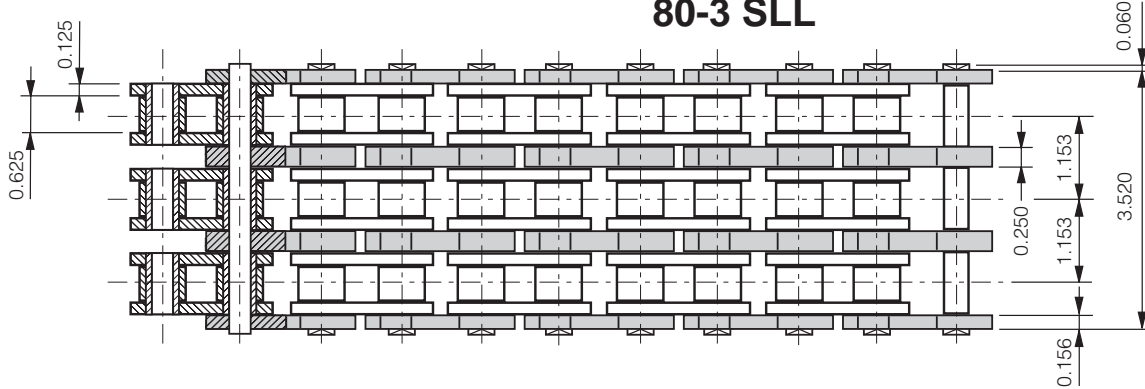

80-4 SLL

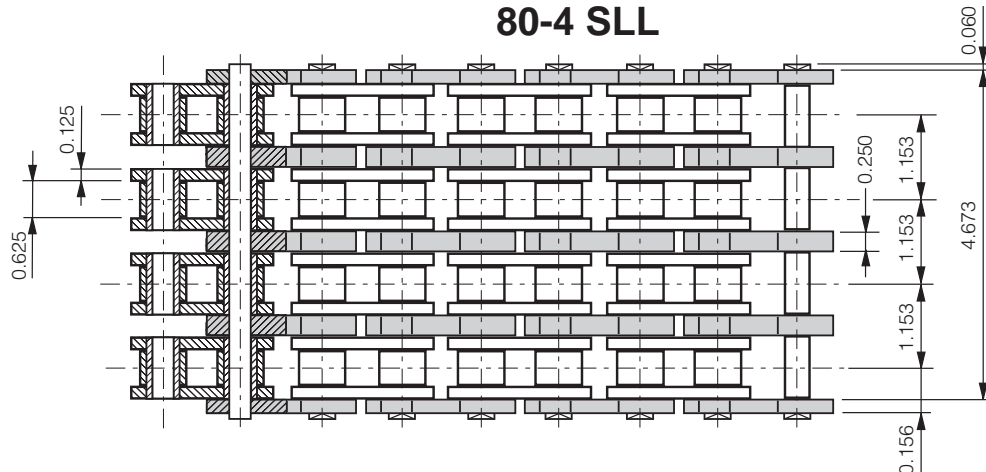

CAN-AM SHARP TOP CHAINS

100 (SLL) SERIES

"SLASHER LOW PROFILE"

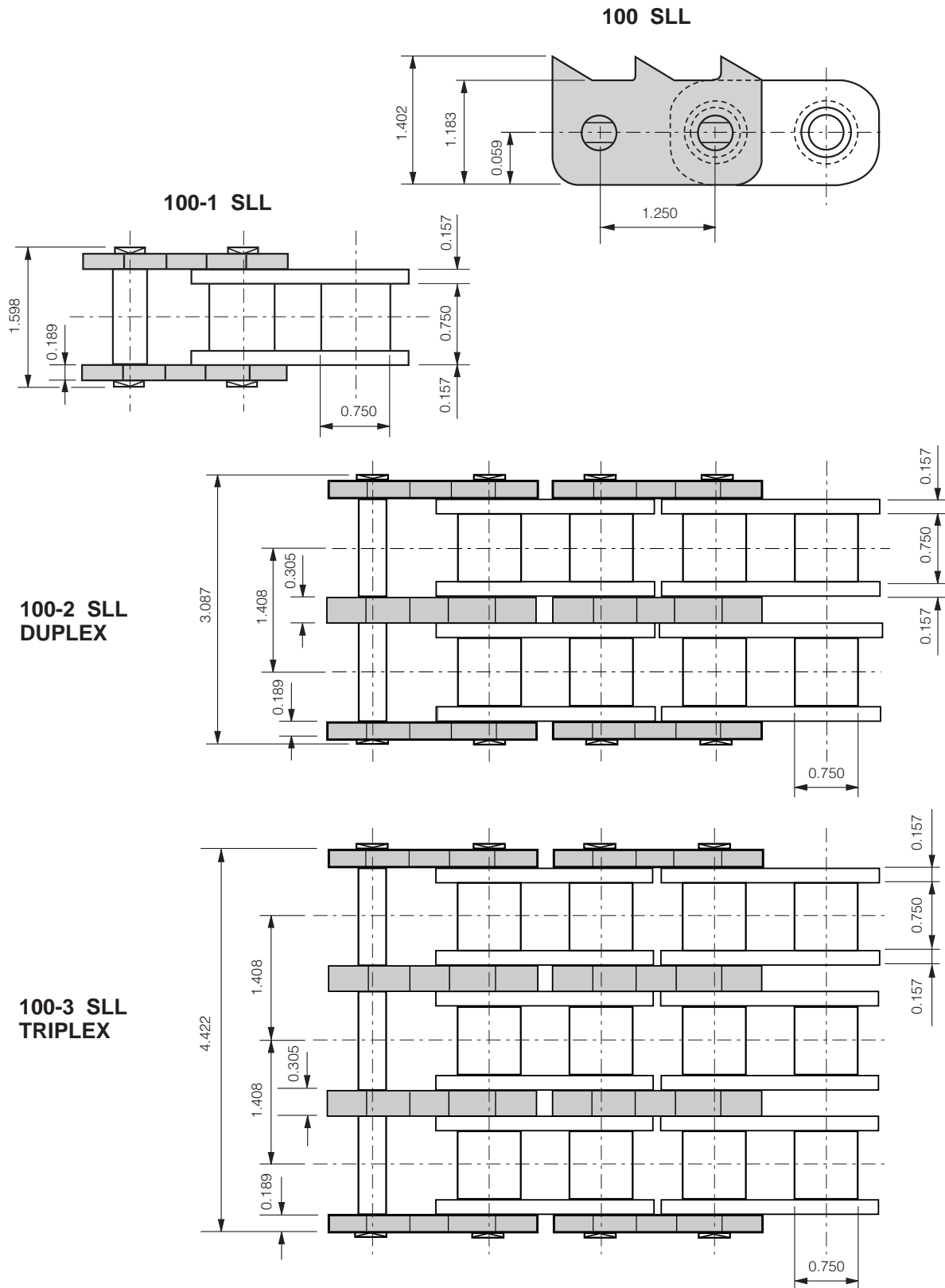

CAN-AM SHARP TOP CHAINS

80 (5 PEP) SERIES

(5 POINT EVERY PITCH)

80 (5 PEP) SERIES

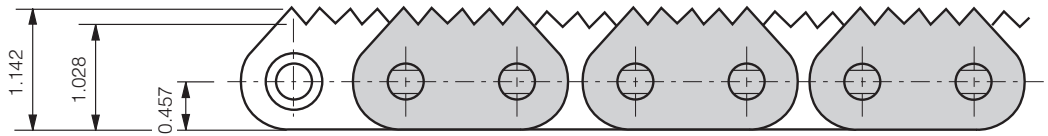

80-2 (5 PEP) DUPLEX

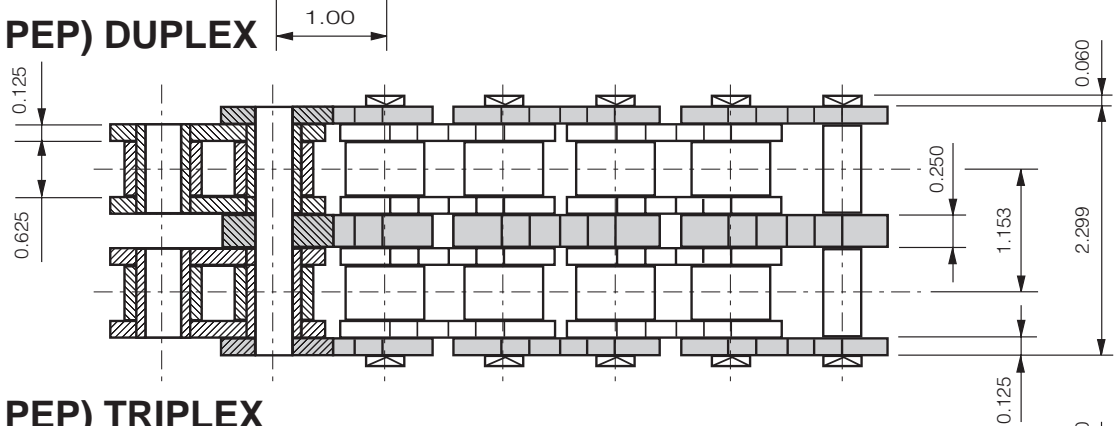

80-3 (5 PEP) TRIPLEX

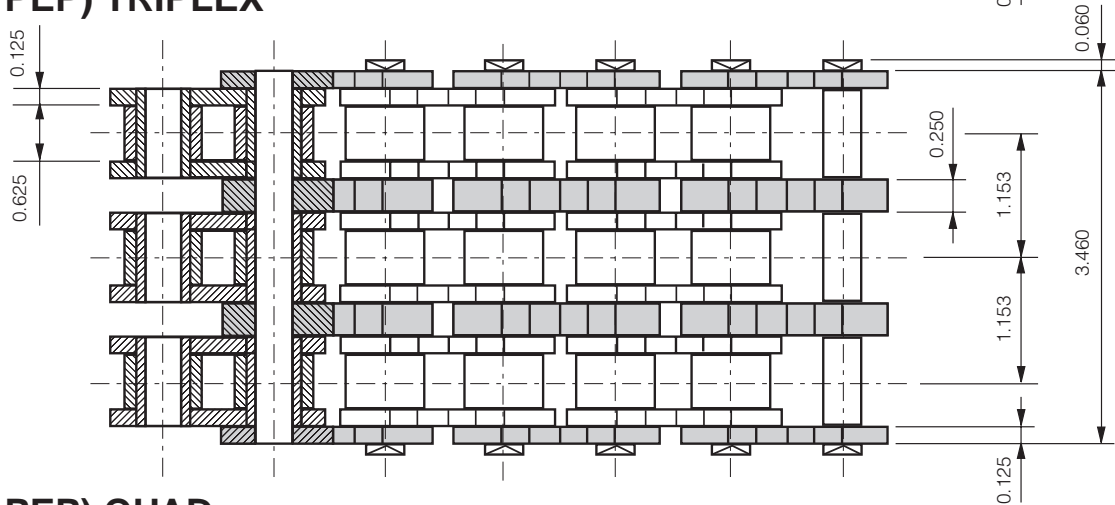

80-4 (5 PEP) QUAD

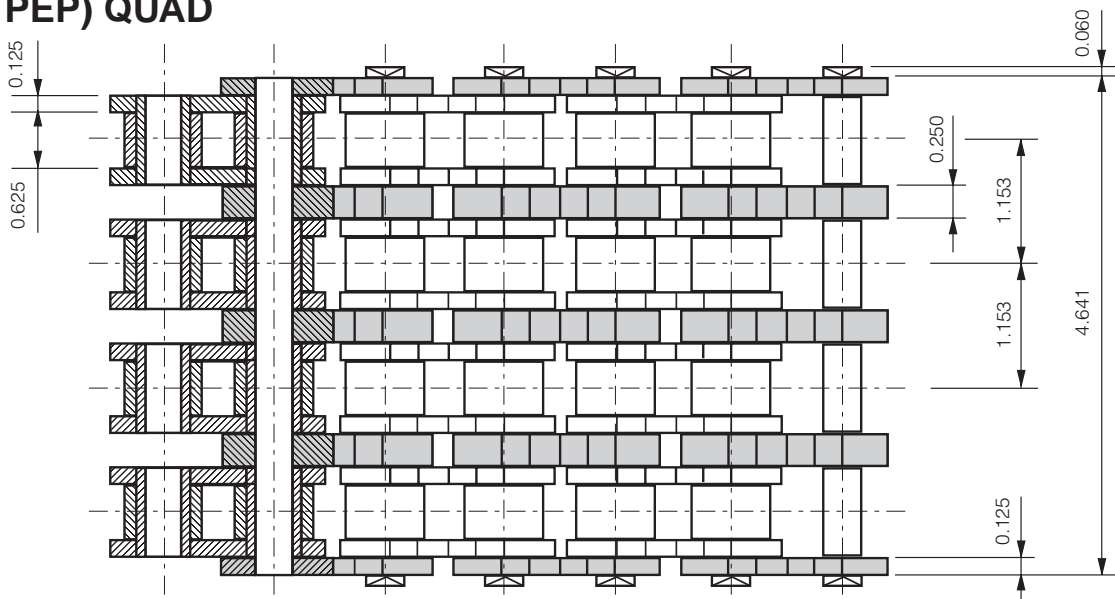

CAN-AM SHARP TOP CHAINS

80-3 (W2P/W4P) SERIES

WAFFERIZER CHAIN

80-3 W2P/W4P SHARP TOP CHAIN

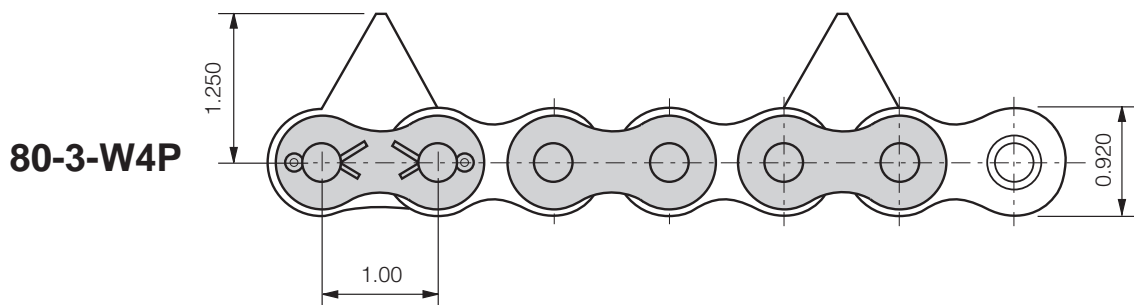
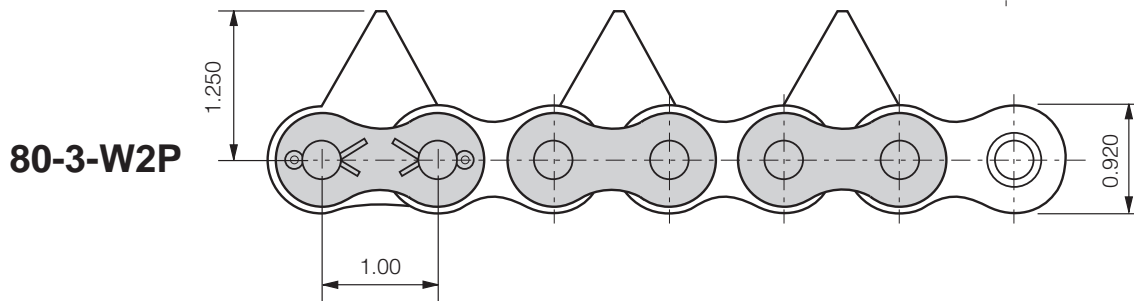
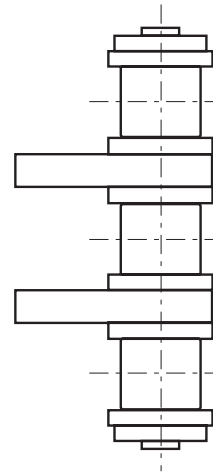
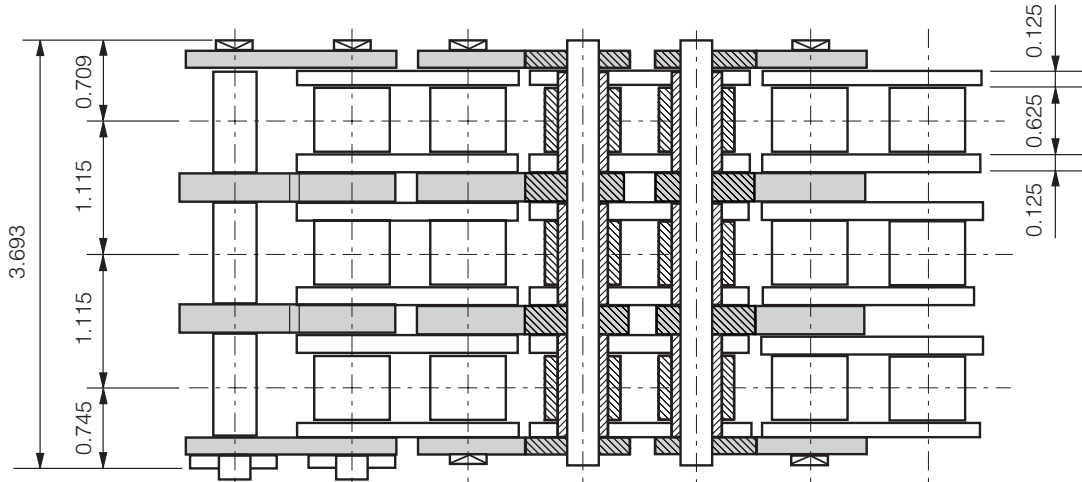

CAN-AM SHARP TOP CHAINS

160-1-DP SERIES

160-1-DP

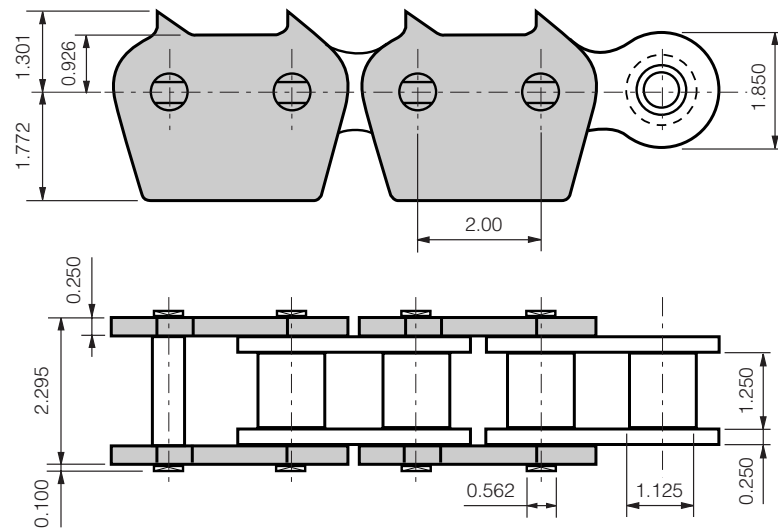

32B SERIES
Narrow Series

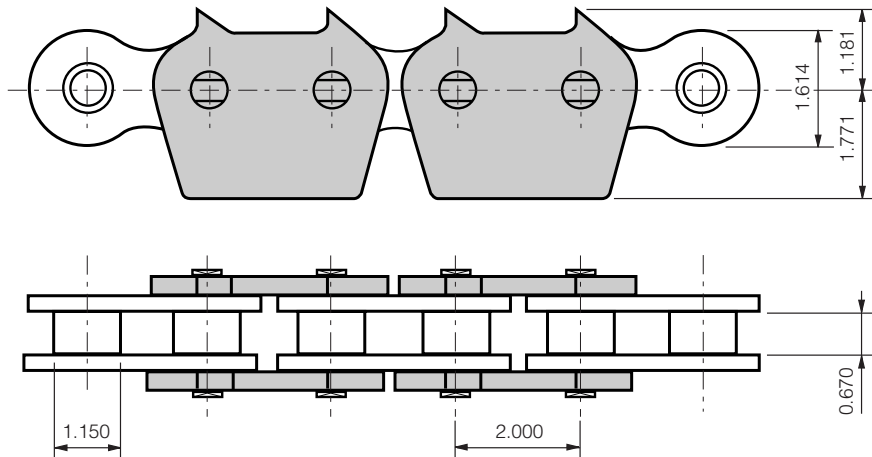

32B SERIES
Standard Series

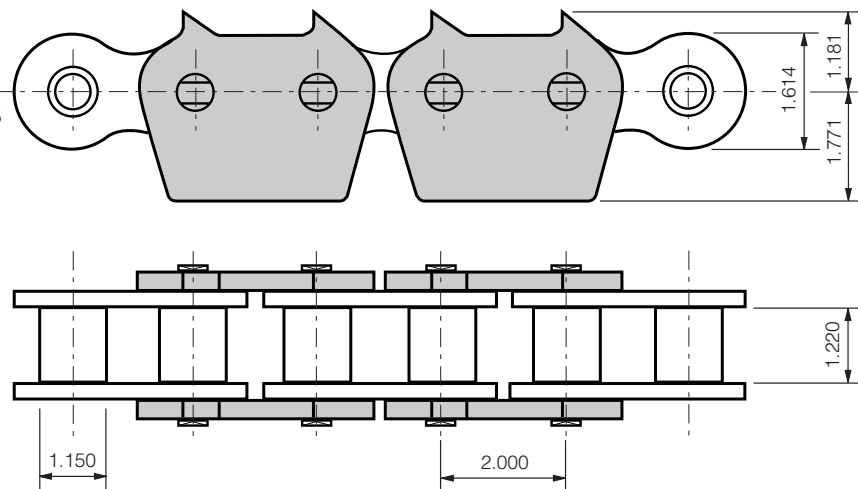

CAN-AM SHARP TOP CHAINS

NEW PRODUCTS

(4 POINT EVERY PITCH) 80-2-4PEP SHARP TOP CHAIN

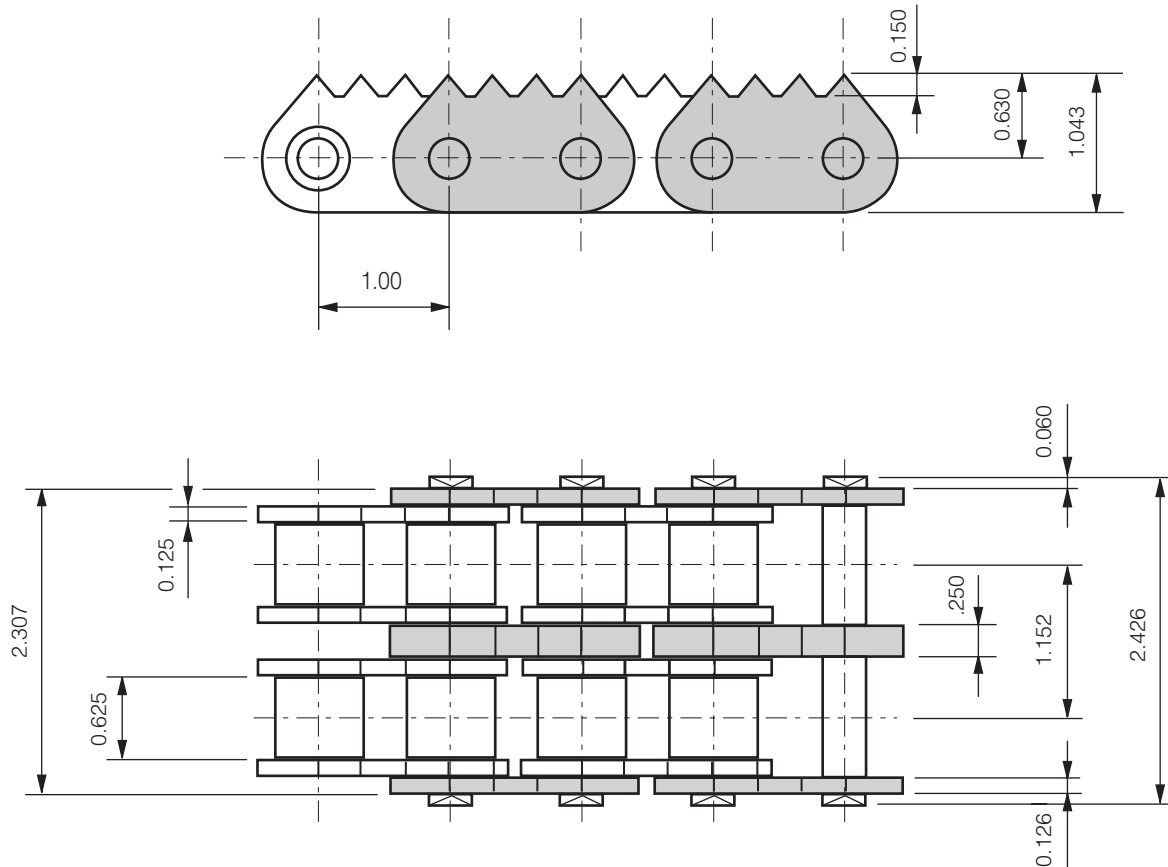

INDUCTION HARDENED SERIES

Tooth hardness of Rc 58-60. IH-Series of Sharp Top Chain is available in selected variations of 80-ST and 80-5PEP products.

80-2-ST-IH

80-3-ST-IH

80-2-5PEP-IH

80-3-5PEP-IH

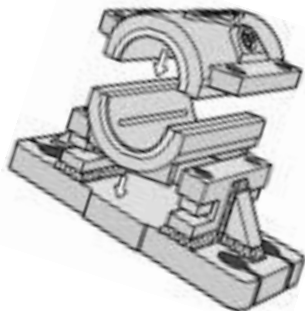
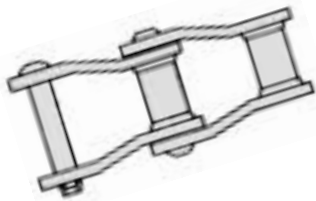
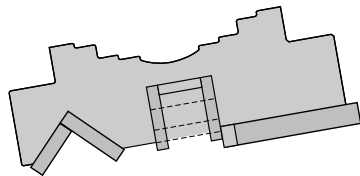
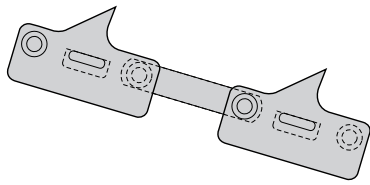

PRODUCTS AND SERVICES PROVIDED BY CAN-AM CHAINS

SHARP CHAINS D.L.I. CHAINS AUTO ROTATE CHAINS

CAN-AM Chains make a full range of specialty chain and flights to suit all facets of industry. Pictured here are two examples of high speed scanner/canter feed chains for the lumber industry.

CAN-AM FABRICATED STEEL SPROCKETS

Normally made of mild steel plate. Heat treated and induction hardened plate sprockets with hardnesses from 360 to 500 BHN are available.

MILL & DRAG CHAIN

CAN-AM's flag ship. We manufacture mill and drag chain for the world.

SPLIT SLEEVE BEARINGS 2-2500 SERIES

CAN-AM manufactures a full line of these bearings and stocks them with liners of polyurethane, bronze, babbitt or Zinc Aluminum.

Please contact us for further information or visit our web site at www.can-amchains.com

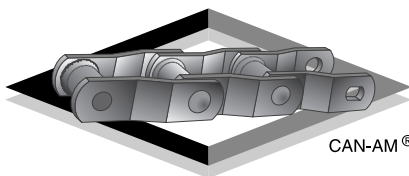

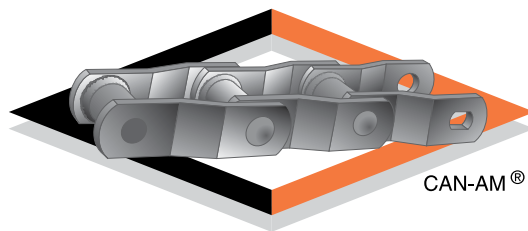
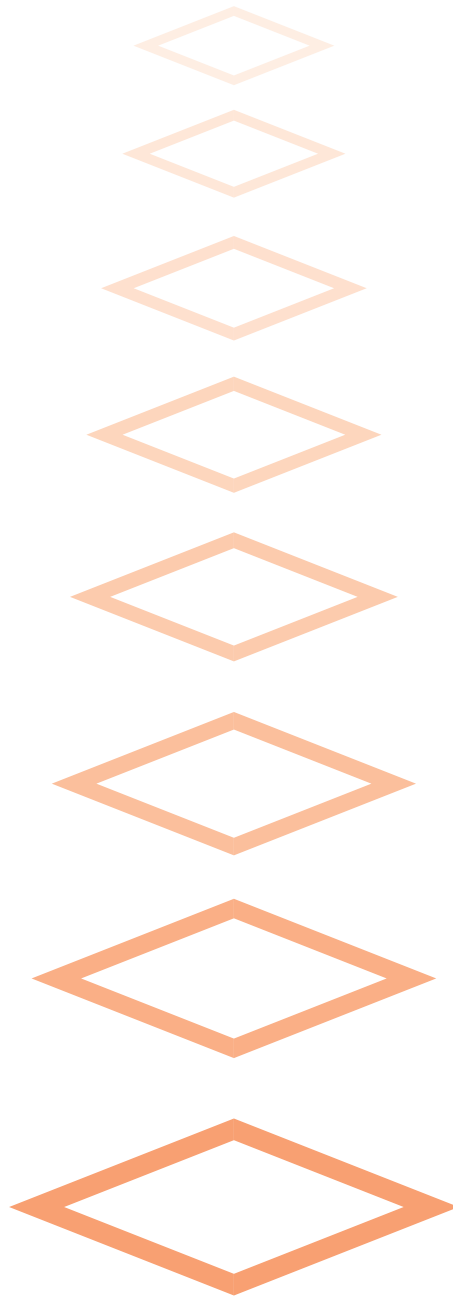

CAN-AM

Challenge Us Today!

SUPPLY SERVICES
performance engineering products

0800 102 112
supplyservices.co.nz